

User and installation manual



aquastream ULTIMATE

ENGLISH: PAGE 1

DEUTSCH: SEITE 35

Current as of February 2024

All information contained in this manual is subject to change without prior notice.
All rights reserved.

Table of contents

1. Preface.....	4
2. Safety precautions.....	4
3. Scope of delivery.....	5
4. Overview of the aquastream ULTIMATE pump.....	5
5. Assembly instructions.....	6
6. Electrical connections.....	6
6.1. Connection panel aquastream ULTIMATE.....	6
6.2. Power Connector.....	6
6.3. Connector "USB".....	6
6.4. Connector "Bus".....	7
6.5. Connector "Flow".....	7
6.6. Connector "RPM".....	7
6.7. Fan connector.....	8
6.8. Connector for temperature sensor.....	8
7. Operation of the aquastream ULTIMATE.....	9
7.1. Initial operation.....	9
7.2. Operation via keys and display.....	9
7.3. Configuration using USB connection.....	10
8. aquasuite software.....	10
8.1. Installation of the aquasuite software.....	10
8.2. Basic operation.....	10
8.3. Symbols in the headlines.....	11
9. Overview pages (aquasuite).....	11
9.1. Desktop mode.....	11
9.2. Creating new overview pages and activating edit mode.....	11
9.3. Adding new elements.....	12
9.4. Editing existing elements.....	12
9.5. Values and names.....	12
9.6. Detailed data elements.....	12
9.7. Log data chart.....	13
9.8. User defined: Images, text, drawing elements.....	13
9.9. Export and import of overview pages.....	13
10. Data quick view and data log (aquasuite).....	14
10.1. Log settings.....	14
10.2. Analyze data.....	14
10.3. Manual data export.....	16
10.4. Automatic data export.....	16
11. Pump configuration.....	16
11.1. Pump mode maximum power/automatic.....	16
11.2. Pump mode speed preset.....	17

11.3. Pump mode aquabus.....	17
11.4. Pump mode deaeration.....	17
11.5. Pump mode temperature set point (Advanced Controller Package only).....	17
11.6. Pump mode curve controller (Advanced Controller Package only) .	17
11.7. Pump mode flow controller (Advanced Controller Package only)....	18
12. Fan configuration.....	18
12.1. Fan mode power preset.....	18
12.2. Fan mode temperature set point.....	18
12.3. Fan mode aquabus.....	18
12.4. Fan mode curve controller (Advanced Controller Package only)....	18
12.5. Fan mode two point controller (Advanced Controller Package only)	19
12.6. Fan settings.....	19
13. Alarm configuration.....	20
13.1. Acoustic alarm.....	20
13.2. RPM header function.....	20
13.3. Alarm reporting and alarm limits.....	20
13.4. System alarms.....	21
14. Sensor configuration.....	21
14.1. External flow sensor.....	21
14.2. Virtual flow sensor (software extension Virtual Flow Sensor only)....	22
14.3. Offsets for temperature sensors.....	22
14.4. Software temperature sensors (Advanced Controller Package only).	22
14.5. Water temperature sensor selection.....	24
15. Display configuration and information pages.....	24
15.1. Display settings.....	24
15.2. Charts.....	24
15.3. Display pages.....	24
16. Profiles.....	24
16.1. Manual profile selection.....	25
16.2. Automatic profile selection.....	25
16.3. Profile configuration.....	25
17. System settings aquastream ULTIMATE.....	25
17.1. Device information.....	25
17.2. Factory defaults.....	25
17.3. aquabus configuration.....	25
17.4. Additional features (aquasuite only).....	26
17.5. Firmware update and language selection (aquasuite only).....	26
18. Playground (aquasuite).....	26
18.1. Input values.....	26
18.2. Virtual Software Sensors.....	27
18.3. Output actions.....	27
18.4. Global profiles.....	28

18.5. Hotkeys.....	28
19. aquasuite web.....	29
19.1. Data export.....	29
19.2. Data access.....	29
19.3. Data import.....	30
20. Basic settings (aquasuite).....	30
20.1. Language.....	30
20.2. Create overview pages.....	30
20.3. Reorder menu items.....	30
20.4. Units.....	30
20.5. Event log.....	30
20.6. Application start-up.....	31
20.7. Service administration.....	31
20.8. Audio and video.....	31
20.9. Updates and update service.....	31
20.10. E-mail and MQTT accounts.....	32
21. Troubleshooting.....	32
21.1. Restore factory defaults.....	32
21.2. Replacement parts.....	33
22. Technical details and care instructions.....	33
22.1. Technical details.....	33
22.2. Care instructions.....	33
22.3. Waste disposal.....	34
22.4. Contact Aqua Computer.....	34

1. Preface

The aquastream ULTIMATE pump is built for longevity and to match the highest quality standards. It has been particularly designed for PC water cooling systems. Each pump is meticulously submitted to a test run; therefore you might find some moist residues within the pump.

Considering the fast technical development, we reserve the right to perform alterations to the products at any time. It therefore is possible that your product does not correspond precisely to the descriptions or especially the illustrations in this manual.

2. Safety precautions

The following safety precautions have to be observed at all times:

- Read this manual thoroughly and entirely!
- Save your data onto suitable media before working on your hardware!
- The pump must not be placed under water!

- The pump controller on the rear end of the pump must not get in contact with water!
- The pump may only be used inside a PC case!
- A short rattle noise upon start-up is normal. If the noise persists for a longer period of time, there might still be some air inside the pump chamber.
- The pump is not a suction pump. Make sure the pump chamber is filled with water prior to operation!
- The pump must never be operated without the rotor! For rotor replacement, only the Aqua Computer rotor with order code 41065 may be used!
- The pump is not suited for dry operation!
- Operate only indoors. Not suited for outdoor operation!
- This product is not designed for use in life support appliances, devices, or systems where malfunction of this product can reasonably be expected to result in personal injury. Aqua Computer GmbH & Co. KG customers using or selling this product for use in such application do so at their own risk and agree to fully indemnify Aqua Computer GmbH & Co. KG for any damages resulting from such application!

3. Scope of delivery

- One aquastream ULTIMATE pump
- One internal USB cable (replacement part no. 53085)
- One aquabus/speed signal cable (3 contacts, replacement part no. 93111)
- One ATX adapter for starting the power supply unit (replacement part no. 93112)

4. Overview of the aquastream ULTIMATE pump

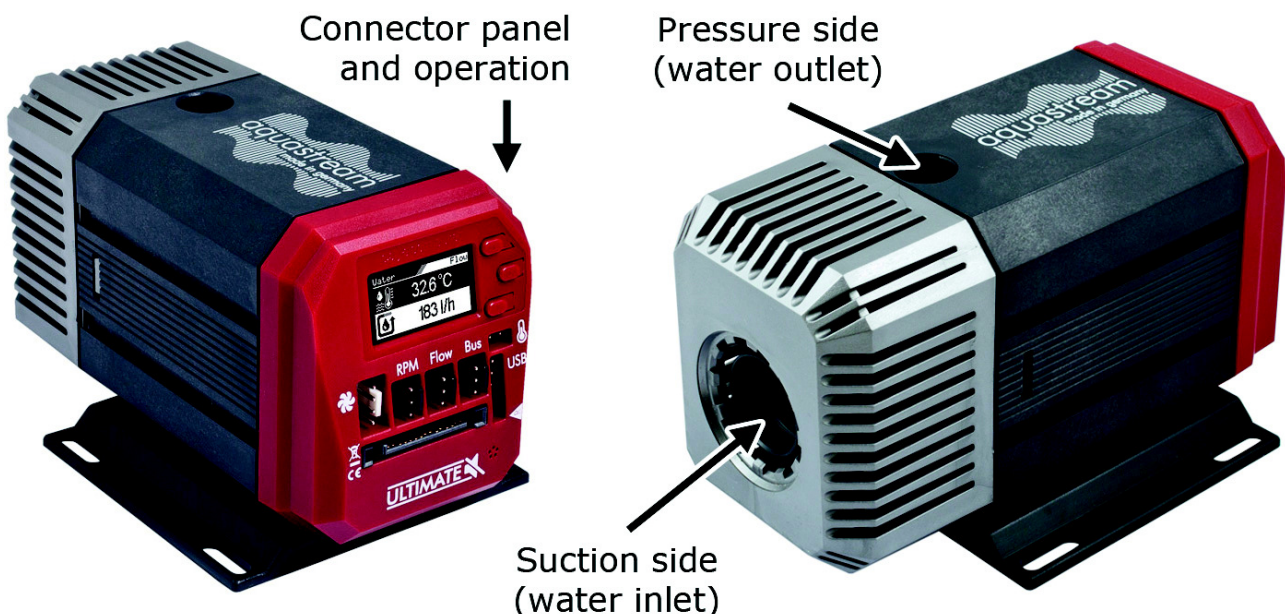

5. Assembly instructions

Install connecting adapters (not included in delivery) to the aquastream ULTIMATE. The adapters should generally be screwed in **without a tool**. The black o-ring must go completely into the pump housing and is not visible if the adapter is correctly installed. Excessive force may damage the pump!

Should you be using a plug-on reservoir with the pump (e. g. aquainlet series), remove the silver suction grille and mount the tank directly onto the water inlet port of the aquastream ULTIMATE pump. In this case no connecting adapter is to be installed into the inlet port.

6. Electrical connections

6.1. Connection panel aquastream ULTIMATE

The pump controller board is integrated on the rear side of the pump. The controller board features connectors for power supply, fan, speed signal, aquabus interface, flow sensor, external temperature sensor and USB interface. **ATTENTION:** Completely turn off your power supply or disconnect the mains power cord from the wall outlet before connecting or disconnecting any cables to/from the device!



6.2. Power Connector

Connect a SATA power plug of your PC's power supply unit to this connector. Do not use excessive force but double check the polarity of the plug if you are having trouble to connect.

Pin assignment: Pin 1, 2, 3, 7, 8, 9, 11: not connected
 Pin 4, 5, 6, 10, 12: GND
 Pin 13, 14, 15: +12 V DC

6.3. Connector "USB"

This connector is used for USB communication with a PC. Connect to an internal USB header of your motherboard. Take special care to make sure the pin alignment matches your motherboard!

The corresponding connector on the motherboard is usually a 9 pin connector with two independent USB ports. Both rows of 4/5 pins can be used to connect an USB device. The black wires (GND) are to be connected to the side of the missing pin, see picture with colored pin assignment.

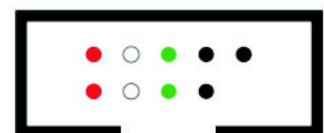

Pin assignment: Pin 1: not connected
Pin 2: GND (black)
Pin 3: D+ (green)
Pin 4: D- (white)
Pin 5: +5 V (red, arrow mark on pump housing)

6.4. Connector "Bus"

Connector for communication with other Aqua Computer devices.

You can use the aquabus/speed signal cable included in delivery to connect the pump controller board to a suitable connector of a compatible device, for example an aquaero. USB and aquabus interface can be used at the same time, however not all control options of the aquastream ULTIMATE are available using the aquabus interface.

Pin assignment: Pin 1: GND
Pin 2: aquabus SDA
Pin 3: aquabus SCL

Compatible aquabus devices:

- aquaero 6 XT (53146, 53206, 53250, 53251, 53262, 53263)
- aquaero 6 PRO (53145, 53253)
- aquaero 6 LT (53234)
- aquaero 5 XT (53089, 53125, 53249)
- aquaero 5 PRO (53090, 53252)
- aquaero 5 LT (53095)

6.5. Connector "Flow"

Flow sensor and special interconnecting cable are optional accessories and not included in delivery.

Pin assignment: Pin 1: GND
Pin 2: flow sensor +5 V
Pin 3: flow sensor signal

Compatible flow sensors:

- Flow sensor with 5.6 mm nozzle (53061, requires cable 53027)
- Flow sensor "high flow" (53068, requires cable 53027)
- Flow sensor high flow LT (53291)
- Flow sensor high flow 2 (53292)

6.6. Connector "RPM"

Depending on configuration, this header can either be used as a generic speed signal or as a "open collector" switching signal.

For monitoring purposes, this speed signal can be deactivated or the switching signal can be activated in case of an alarm condition (for configuration see chapter 13.2). For example, the aquabus/speed signal cable included in delivery can be

used to connect this header to the CPU fan header of the PC's motherboard and depending on the motherboard and BIOS settings, an automatic emergency shutdown may be initiated on alarm condition. Please refer to the motherboard manual for details on functionality and BIOS settings.

Alternatively, if configured as "power switch (53217)", this connector can be connected to the power switch header of the motherboard using an additional specialized cable (art. 53217, not included in delivery).

Pin assignment: Pin 1: GND
 Pin 2: not connected
 Pin 3: speed signal/open collector max. 30 V / 100 mA

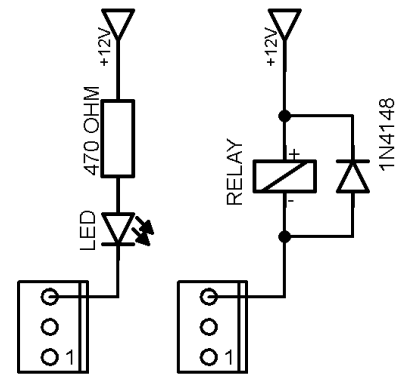

6.7. Fan connector

Voltage or PWM regulated fan output. Maximum current is 1 A independent of output voltage, resulting in a maximum power of 12 W at 12 V, short-term (less than 1 second) maximum current is 1.5 A. If output current exceeds 1.5 A or 1 A for a longer period of time, the output will be permanently disabled and a system alarm (with alarm buzzer) is triggered. To reactivate the output, the aquastream ULTIMATE (or the complete PC) has to be disconnected from power for a short period of time. The fan output is short-circuit proof.

If required, multiple fans can be connected using standard fan splitter cables as long as the total current does not exceed output specifications.

Pin assignment: Pin 1: GND
 Pin 2: 0-12 V DC output
 Pin 3: Speed signal
 Pin 4: PWM signal

6.8. Connector for temperature sensor

Connector for a temperature sensor.

Compatible sensors:

- Temperature sensor inline G1/4 (53066)
- Temperature sensor inner/outer thread G1/4 (53067)
- Temperature sensor G1/4 (53147)
- Temperature sensor plug&cool (53025)
- Temperature sensor 70 cm (53026)

7. Operation of the aquastream ULTIMATE

7.1. Initial operation

Turn off your PC or remove the PSU mains cable if the PSU does not have a power switch. Remove all cables of the PSU (e. g. from non removable disks, optical storage drives or graphic cards). Take special care to disconnect the 4pin or 8pin ATX12V power supply connector from the motherboard as well. Connect the power connector of the aquastream ULTIMATE to an available SATA power plug of the power supply unit.

To operate your aquastream ULTIMATE while filling the system, you have to either start the PC power supply with the enclosed ATX start plug or attach the pump to a second power supply unit.

To start the power supply unit, plug the ATX start plug onto the 20pin or 24pin ATX power supply connector of the PSU. After you have attached the plug to the PSU and turned on the mains switch of the PSU, the PSU and pump will immediately power up. Proceed by filling the water cooling system with coolant.

Important: If you hear rattling noises from the pump, they are most likely caused by air inside the pump. You can accelerate the deaeration process by carefully tilting the pump or by activating the deaeration mode of the pump.

After completing the filling process, turn off the PSU and remove the ATX start plug. Attach all previously disconnected hardware components of the PC to the power supply unit again.

Please note: Some high-power PSUs will not be able to power the aquastream ULTIMATE without further electrical load due to power regulation problems. In this case, use a second (complete) PC or a separately sold PSU for single components for the filling process. Alternatively, connect further load like hard disk drives and optical drives to the PSU.



7.2. Operation via keys and display

The aquastream ULTIMATE is equipped with an OLED display and three keys and can be fully configured using these.

The upper and lower key will select information pages during display mode and select and alter menu entries. The middle key will open the device menu while in display mode and confirm selected menu entries or values while in the menu.

During configuration via keys and display, the aquasuite software should be closed on a connected PC! Otherwise, the aquasuite will overwrite and thereby cancel any settings made on the device itself.

7.3. Configuration using USB connection

The aquastream ULTIMATE can be connected to a PC via USB interface and can then be configured using the aquasuite software. Comprehensive visualization and logging options are also available in the aquasuite software. However, an USB connection is not required for operation.

8. aquasuite software

The Windows software aquasuite is an extensive software suite and can be used for configuration and monitoring. The software is not required for operation though. All configuration parameters can be saved into the device's memory.

Please note: Depending on the type of product you are using, some features may not be available for your device.

8.1. Installation of the aquasuite software

For configuration and monitoring of our products with USB interface, the aquasuite software is available for download from our website www.aqua-computer.de. You will find the setup program in the support section of the website under Downloads/Software.

The setup program checks all connected USB devices for embedded update service periods and offers various aquasuite versions depending on detected devices. If no device with update service for the latest aquasuite version is found, a warning is displayed and older aquasuite versions that do not require an update service purchase can be selected for installation. For installation and update service validation, an internet connection is required.

The latest aquasuite version may also be installed if no suitable update service period has been found in a device. Subsequently, update service may be purchased or an existing key may be entered within the aquasuite. These functions can be accessed in the aquasuite/Updates tab.

8.2. Basic operation

The program window is divided into two main areas. On the left side, a list of "overview pages", data quick view, data logger, device pages, aquasuite web and aquasuite configuration is displayed, the right side shows the details of the currently selected list element. The list can be hidden or restored by clicking the arrow symbol in the upper left corner.

List elements may be minimized or maximized for easier access by clicking the title bar. The title bars may contain various symbols that will be explained in the following chapter.

8.3. Symbols in the headlines



Click the plus symbol in the “Overview pages” headline to create a new overview page.



Clicking the monitor symbol will toggle desktop mode for this overview page. While desktop mode is active, the color of the symbol will change to orange.



Overview page: Clicking the padlock symbol will unlock or lock this overview page for editing. Device: Device can not be used due to update service problems, see “Updates and update service” for details.

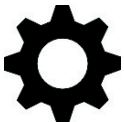

Clicking the gear symbol will access the basic configuration page of the selected list element.



In order to save all settings into a device, click the disk symbol in the headline.



This symbol indicates that communication with this device is not possible at the moment. Check USB connection and power supply of the device if necessary.

9. Overview pages (aquasuite)

Current sensor readings and diagrams from all supported devices can be displayed in overview pages. For each device a pre-configured overview page is automatically generated the first time the device is connected to the PC. These pages can be individually modified and new pages can be created. Within one overview page, data from all connected devices can be accessed.

9.1. Desktop mode

Each overview page can be displayed directly on your desktop. You can enable desktop mode for an overview page by clicking the monitor symbol in the list of overview pages. Desktop mode can only be enabled for one overview page at a time. With desktop mode enabled, elements of the overview page may cover program symbols on your desktop, but mouse clicks are transmitted to underlying desktop symbols.

If a overview page is unlocked for editing while desktop mode is active, the page will be displayed in the aquasuite window for editing and the current desktop will be displayed as background for your convenience.

9.2. Creating new overview pages and activating edit mode

In order to create a new overview page, click the plus symbol in the headline “Overview pages”.

Existing overview pages can be unlocked for editing by clicking lock symbol in the page listing.

9.3. Adding new elements

If the currently selected overview page is unlocked for editing, a plus symbol is displayed in the top right corner of the screen. Click the symbol to add a new element to the page and select the desired element from the following list. All available data is displayed in a tree diagram, click the arrow symbols to access individual items.

Confirm your selection by clicking the check symbol in the bottom right corner. The new element will be displayed in the upper left corner and the configuration window is displayed. Configure the element as described in the next chapters.

9.4. Editing existing elements

If the currently selected overview page is unlocked for editing, right-clicking an element will access a context menu.

To access the settings of an element, select "Settings" in the context menu or simply double click the element. If you want to move an element, "drag" this element while holding down the mouse button. Release the mouse button when the element is at the desired position.

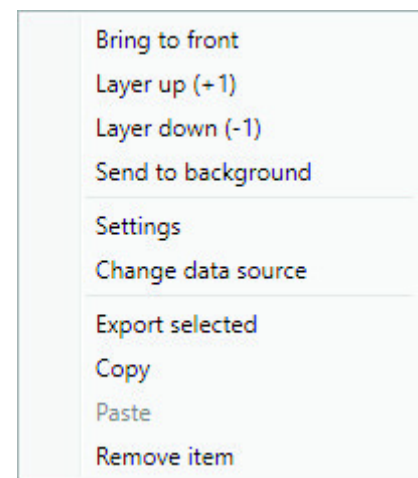

9.5. Values and names

If the currently selected overview page is unlocked for editing, right-click an element and select "Settings". You may also double click the element.

Font face, size and color as well as position, decimal places and unit can be configured for individual values.

9.6. Detailed data elements

If the currently selected overview page is unlocked for editing, right-click an element and select "Settings". You may also double click the element. Apart from position, size and color, the style of the element can be selected and configured. The following styles are available:

- **Headline only:** Compact display as a headline.
- **Text:** Displays the numerical value in a box with a headline.
- **Bar graph:** Displays numerical value as well as bar graph.
- **Chart:** Displays the value in chronological sequence as a chart.
- **Gauge:** Displays the value as an analog gauge.

All display styles offer extensive configuration options, additionally statistical data such as minimum, maximum and average can be displayed.

9.7. Log data chart

This element can be used to display charts on overview pages. The charts have to be created using the data log functionality of the aquasuite before they become available for overview pages. Please refer to the next chapter for details. Once a chart has been configured, it can be selected from the “Chart selection” list on the “Display” tab of the settings dialog.

9.8. User defined: Images, text, drawing elements

By using user defined controls, simple drawing elements such as circles, rectangles and texts as well as images and more sophisticated elements can be added to an overview page. To do so, add an “User defined” element to an overview page. Switch to the “Display” tab in following dialog box, select the type of element to be created from the drop down menu and confirm your selection by clicking the “Load preset” button. Depending on the type of element, an additional dialog may appear before the code (XAML, Extensible Application Markup Language) of the new element is displayed in the lower part of the dialog window. You may want to customize the code. By clicking the “Ok” Button, the new control is saved to the overview page.

Step-by-step example to add an image: Select “Image” from the drop down menu and click the “Load preset” button. Select an image file using the following file selection dialog. The code is then displayed in the lower part of the dialog window and can be modified. Save the new control by clicking the “Ok” button. The picture will be displayed on the overview page.

More complex controls such as data bindings and animations are also available but will require some programming experience for configuration.

9.9. Export and import of overview pages

Elements and complete overview pages can be exported from the aquasuite and can then be imported either on the same PC or on other PCs. For export as well as import, the overview page must be in edit mode.

To export a complete page, right click a free spot of the page and select “Export page” from the context menu. To export individual elements, select the element or elements, perform a right click and select “Export selected” from the context menu. For import, right click a free spot of the page and select “Import page” or “Import items” from the context menu. Using “Import page”, the current page will be deleted and only the imported page items will be displayed, using “Import items” will add the items from file to the current page without altering the existing items. During import, the elements will be assigned to devices using the following scheme:

If a device with identical serial number is found on the computer, no changes are made.

If no device with identical serial number is found on the computer, the element will be assigned to the first device found of identical type.

When importing complex pages with elements referring to more than one device, it is recommended to edit the device assignment in the file using a text editor prior to importing.

10. Data quick view and data log (aquasuite)

All data currently monitored by the aquasuite can be accessed in the “Data quick view” section. This includes data from connected USB devices as well as hardware data supplied by the Aqua Computer background service. Displayed data may be filtered using the text box next to the magnifier icon, a chart shows the development over a maximum of ten minutes. All data shown here is not stored permanently.

In contrast, the “Data log” may be used to selectively and permanently store data from all connected Aqua Computer devices and hardware data supplied by the background service. Logged data can then be analyzed by creating charts or be exported to files. Data is only logged while the aquasuite software is being executed.

10.1. Log settings

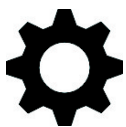

The log settings can be accessed by clicking the “Log settings” element below the “Data log” headline in the listing. To log data, create a new log data set by clicking the plus symbol in the upper right corner of the settings window. Enter name, time interval and configure automatic deletion of old data to meet your requirements. You may then add the data sources to log by clicking the plus symbol in the “Data sources” window section. You may add an unlimited number of data sources to each log data set, the total number of log data sets is also unlimited.

10.2. Analyze data



Logged data can be visually evaluated as charts. To do so, select “Analyze data” below the “Data log” headline in the listing. The chart will initially be empty, directly below the chart are eight buttons to modify the chart. In the lower section of the window, the chart data can be configured.

To add data to the chart, first select the “Data sources” tab in the chart configuration and select a data set to be displayed. If no data sources are available, you will have to configure the log settings as described in the chapter “Log settings” of this manual. Select the time period to be displayed on the right side of the window and add the data to the chart by clicking the “Add data to chart” button. Repeat this procedure if you want to display more than one data set in the chart.

You may modify the chart using the “Chart setup” and “Data series setup” tabs. Finally, you can use the “Chart manager” tab to save the current chart configura-

tion and to load or delete previously saved configurations. All saved chart configurations will be available on overview pages for the “Log data chart” element. The currently displayed chart can be edited by using the buttons directly below the chart and may also be saved as an image file. The button corresponding to the currently selected function is highlighted by an orange frame. Please refer to the following list for details on each function:



To save the currently displayed chart as an image file, click the floppy disk symbol and select a name and location in the following dialog.

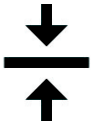

This function can be used to add horizontal lines to the chart. While this function is activated, simply click into the chart to add a line at the current cursor position.

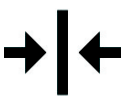

This function can be used to add vertical lines to the chart. While this function is activated, simply click into the chart to add a line at the current cursor position.



This function can be used to add annotations to the chart. While this function is activated, simply click into the chart to add an annotation at the current cursor position. By clicking into the text box, you may edit the text. You may also drag the little circle beside the text box to move the connecting line to the desired position. Use drag and drop to move existing annotations.



This function can be used to remove horizontal/vertical lines or annotations from the chart. While this function is activated, simply click the element to be removed.

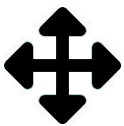

This function can be used to move the visible portion of the chart. Press and hold the mouse button while moving the cursor in the chart to select the position to be displayed, then release the button.



This function can be used to zoom in and out. Use the mouse wheel or select the area to be displayed. You can reset the zoom settings by double-clicking in the chart area.

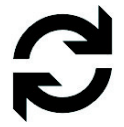

This function can be used to reload and update the chart.



This function will completely remove the chart.

10.3. Manual data export

Saved data can be exported from the data log into a XML file. To do so, select “Analyze data” below the “Data log” headline in the listing. Select the “Data sources” tab in the chart configuration and select a data set to be exported. If no data sources are available, you will have to configure the log settings as described in the chapter “Log settings” of this manual. Select the time period to be exported on the right side of the window and start the export process by clicking the “Export data” button. Enter a file name and path in the following dialog window.

10.4. Automatic data export

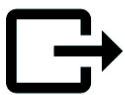

The automatic data export feature can be used to save data from the aquasuite into an XML file on the hard disk or in the RAM (“memory mapped file”) in a regular time interval. The automatic data export will always overwrite the previously saved data, so the file always contains only the most recent data set. Select “Automatic data export” below the “Data log” headline in the listing to access the settings screen. Create a new export data set by clicking the plus symbol in the upper right corner of the screen. Enter name, path and time interval to meet your requirements. You may then add the data sources to log by clicking the plus symbol in the “Data sources” window section. You may add an unlimited number of data sources to each export data set, the total number of export data sets is also unlimited.

11. Pump configuration



aquasuite: Select “Pump” from the device list below the “aquastream ULTIMATE” entry. In the upper area, current pump data is displayed as plain text as well as in a diagram. Select the desired mode of operation below the diagram.

Device menu: Select “Pump” from the menu list and confirm by pressing the middle key.

11.1. Pump mode maximum power/automatic

If maximum power/automatic mode is selected, the pump will automatically operate at the highest attainable speed. The pump controller constantly monitors rotor orientation, electrical current, power dissipation and supply voltage to calculate optimum rotation speed. Using a standard water cooling setup, this speed will normally be around 4000 – 5000 rpm depending on the resistance of the system.

If “Manual speed settings” is selected, you can set the rotation speed of the pump manually. If the selected speed cannot be attained, the pump controller will use the highest stable rotation speed (below the set speed) just like in automatic mode.

11.2. Pump mode speed preset

If speed preset mode is selected, you can manually set the desired rotation speed of the pump. If the selected speed cannot be attained, the pump controller will use the highest stable rotation speed just like in automatic mode.

11.3. Pump mode aquabus

This mode can be used to control pump speed by an aquaero 5/6 controller connected to the pump via aquabus. If no data is transmitted to the pump via aquabus, the pump controller will use the highest stable rotation speed just like in automatic mode.

11.4. Pump mode deaeration

While in deaeration mode, the pump will stop and run at top speed at regular intervals to speed up the deaeration process. Deaeration mode is deactivated after ten minutes.

11.5. Pump mode temperature set point (Advanced Controller Package only)

This mode can be used to automatically adjust pump speed depending on the current temperature reading of one of the up to four available temperature sensors. The desired target temperature can be configured, all other parameters should not be changed for normal operation.

Please note that pump speed and the resulting changes in flow rate have only a minor influence on temperatures in a typical water cooling setup. This mode may therefore not effect the expected results.

11.6. Pump mode curve controller (Advanced Controller Package only)

This mode can be used to automatically adjust pump speed depending on the current temperature reading of one of the up to four available temperature sensors. The controller curve can be configured by assigning output values to 16 corresponding temperature values. The output values in percent correlate to the pump speed range from 3000 to 5500 rpm. So a value of 50 % correlates to a pump speed of 4250 rpm, a change of 1 % correlates to a speed change of 25 rpm. If the selected speed cannot be attained, the pump controller will use the highest stable rotation speed instead.

In the aquasuite, controller curves can easily be adjusted using drag & drop and curves can automatically be generated from start and end points. In the graphical curve display, the currently displayed area can be changed using the following methods:

- Mouse wheel movements will zoom in and out.
- A double click on an axis will reset zoom level for this axis, a double click into the diagram will reset both axes.

- Selecting an area on an axis will zoom this axis to this area, selecting an area in the diagram will zoom both axes to this area.
- Mouse movement while right button is pressed will move the displayed area of the diagram.

11.7. Pump mode flow controller (Advanced Controller Package only)

This mode can be used to automatically adjust pump speed depending on the current flow rate. This requires either an additional external flow sensor or the purchase of the virtual flow sensor software extension. The desired flow rate can be configured between 30 to 300 liters per hour.

12. Fan configuration



aquasuite: Select “Fan” from the device list below the “aquastream ULTIMATE” entry. In the upper area, current fan data is displayed as plain text as well as in a diagram. Select the desired mode of operation below the diagram.

Device menu: Select “Fan” from the menu list and confirm by pressing the middle key.

12.1. Fan mode power preset

If power preset mode is selected, you can manually set the desired output power of the fan output. The values in percent correlate to the either the voltage range from 0 V to 12 V in voltage controlled mode or the PWM ratio range from 0 % to 100 % in PWM controlled mode.

12.2. Fan mode temperature set point

This mode can be used to automatically adjust fan speed depending on the current temperature reading of one of the up to four available temperature sensors. The desired target temperature can be configured, all other parameters should not be changed for normal operation.

12.3. Fan mode aquabus

This mode can be used to fan speed by an aquaero 5/6 controller connected to the pump via aquabus. If no data is transmitted to the pump via aquabus, the fan output will be set to maximum power.

12.4. Fan mode curve controller (Advanced Controller Package only)

This mode can be used to automatically adjust fan speed depending on the current temperature reading of one of the up to four available temperature sensors. The controller curve can be configured by assigning output values to 16 corresponding temperature values.

The output value in percent corresponding to the current temperature is scaled to the range between minimum and maximum fan power settings before being applied to the fan output.

The startup temperature will also be factored into the controller output. The output power defined in the curve controller will be ignored and set to 0 % as long as the input temperature has not exceeded the defined startup temperature for the first time. After the startup temperature has been exceeded, the output will strictly be set according to the defined curve until the output value goes down to 0 % again. This will trigger the startup process again, meaning the temperature has to exceed the defined startup temperature again before the curve will be in effect once more. This behavior is meant to prevent fans assigned to the curve controller to be switched on and off in rapid succession. If the first point on the curve is set to a power greater than 0 %, this behavior is deactivated.

In the aquasuite, controller curves can easily be adjusted using drag & drop and curves can automatically be generated from start and end points. In the graphical curve display, the currently displayed area can be changed using the following methods:

- Mouse wheel movements will zoom in and out.
- A double click on an axis will reset zoom level for this axis, a double click into the diagram will reset both axes.
- Selecting an area on an axis will zoom this axis to this area, selecting an area in the diagram will zoom both axes to this area.
- Mouse movement while right button is pressed will move the displayed area of the diagram.

12.5. Fan mode two point controller (Advanced Controller Package only)

The two point controllers mode will result in switching the fan output on and off when the temperature reading of the selected temperature sensor rises above/falls below predefined values.

12.6. Fan settings

Depending on currently selected fan mode, additional parameters can be configured.

In voltage controlled mode (for conventional 3-pin fans), output voltage is adjusted to control the fan. In PWM mode (for 4-pin PWM fans), a PWM signal is generated and adjusted on the dedicated PWM pin, output voltage is set to 12 V.

The start boost feature can be used to reliably power up a fan or pump connected to the output. If activated, the aquastream ULTIMATE controller will set the fan output to the 100 % power for a short duration before switching to normal operation whenever the output power changes from exactly 0 % setting to a higher value.

The fan output range can be limited by setting "Minimum power" and "Maximum power" values correspondingly. The check box "Hold minimum power" determines whether the fan will be switched off during a power setting of 0 % (box not

checked) or remain active at the set minimum speed (box checked). Set minimum power to a value at which the connected fan reliably starts up.

The “Maximum rotation speed of connected fan” setting applies only to diagram scaling within the aquasuite and has no effect on the fan output.

13. Alarm configuration



aquasuite: Select “Alarms” from the device list below the “aquastream ULTIMATE” entry.

Device menu: Select “Alarms” from the menu list and confirm by pressing the middle key.

13.1. Acoustic alarm

This parameter determines whether the alarm buzzer will be activated during alarm conditions. The alarm buzzer is always active for non-configurable systems alarms regardless of this setting.

13.2. RPM header function

Select the signal to be provided through the speed signal output:

- Speed signal disabled during alarm: A speed signal is generated as long as no alarm condition is detected. Allows for alarm monitoring if RPM header of the pump is connected to a fan header with speed signal monitoring.
- Speed signal permanently on: Speed signal is always generated regardless of alarm events.
- Power switch (53217): This mode can be used for emergency shutdown of the PC, if the “RPM” header is connected to the power switch header of the motherboard using a suitable cable (art. 53217). Before connecting the cable, make sure the pump is configured correctly! After connecting the cable, test the setup by deliberately creating an alarm condition. If the PC is not shut down, the cable header connected to the motherboard must be rotated by 180 degrees and the test has to be repeated. Emergency shutdown may result in data loss as operating system and running programs are not shut down properly!

13.3. Alarm reporting and alarm limits

Select the data sources to be monitored and set appropriate alarm limits. If the current reading is below the limit (flow sensors) or higher than the limit (temperature sensors) or no fan speed signal is detected, an alarm will be raised if the check box “Activate alarm evaluation” is set for this value.

While an alarm condition is detected, the pump display will permanently show a corresponding information screen. If more than one alarm is active, the displayed information will alternate between corresponding screens in short order. To

change the alarm configuration, you may still access the menu during alarm conditions by pressing the middle key next to the display.

On the alarm page within the aquasuite, all sources that currently raise an alarm are highlighted with a red background color. Alarms that have been active at least once since pump start-up, but are not active presently, are highlighted with a yellow background color.

Make sure only to use readings for alarm evaluation that are functional with your specific setup.

13.4. System alarms

System alarms are raised for severe malfunctions and can not be configured. **If a system alarm is detected, the water cooling system will be either inoperational or severely impaired, instant action (shutdown of the PC) is mandatory!** The alarm buzzer is activated whenever a system alarm is detected.

The following system alarms can be detected:

- Supply voltage too high: Pump function deactivated, fan output deactivated. **Shut down PC immediately!**
- Supply voltage too low: Pump operational with reduced power, fan output deactivated. **Shut down PC immediately if fan output is required!**
- Pump current too high: Pump function deactivated. **Shut down PC immediately!**
- Pump current too low: Pump function deactivated. **Shut down PC immediately!**
- Fan current too high: Fan output deactivated. **Shut down PC immediately!**
- Fan amp error: Fan output deactivated. **Shut down PC immediately!**

14. Sensor configuration



aquasuite: Select "Sensors" from the device list below the "aquastream ULTIMATE" entry.

Device menu: Select "Sensors" from the menu list and confirm by pressing the middle key.

14.1. External flow sensor

Calibration values for sensors sold by Aqua Computer can conveniently be selected from a drop-down list. Select the appropriate entry for the flow sensor connected to the aquastream ULTIMATE.

If necessary, the flow rate can be calibrated by $\pm 10\%$.

14.2. Virtual flow sensor (software extension Virtual Flow Sensor only)

If the software extension “Virtual Flow Sensor” is activated, the aquastream ULTIMATE continuously calculated the current flow rate from a variety of pump parameters.

If necessary, the flow rate can be calibrated by $\pm 10\%$. Flow rates below 40 l/h will not be displayed due to increasing imprecision of the calculation method for low flow rates.

Limitations: Flow rate can not be calculated if a second pump is present in the cooling circuit! Flow rate calculation is calibrated for DP Ultra viscosity and will deviate when using other coolants or pure water!

14.3. Offsets for temperature sensors

If necessary, each temperature sensor can be calibrated by adding an offset of $\pm 15\text{ }^{\circ}\text{C}$.

14.4. Software temperature sensors (Advanced Controller Package only)

Software temperature sensors can be used to transfer temperature sensor readings to the aquastream ULTIMATE from the computer by USB connection or from an aquaero 5/6 by aquabus connection.

Transmission of sensor data via USB interface

During installation of the aquasuite, the background service “Aqua Computer Service” is also installed. This service supplies various data from PC components and imported data from aquasuite web, additionally sensor data provided by third party software can be accessed. In order to access third party software data, the third party software has to be correctly installed, configured and running.

Currently, the “Aqua Computer Service” supports data transfer from “HWiNFO” (REALiX, Freeware, www.hwinfo.com) and “AIDA64” (FinalWire Ltd., subject to license fees, www.aida64.com).

In the HWiNFO settings menu, “Shared Memory Support” must be activated and the “Sensor Status” window has to be open:

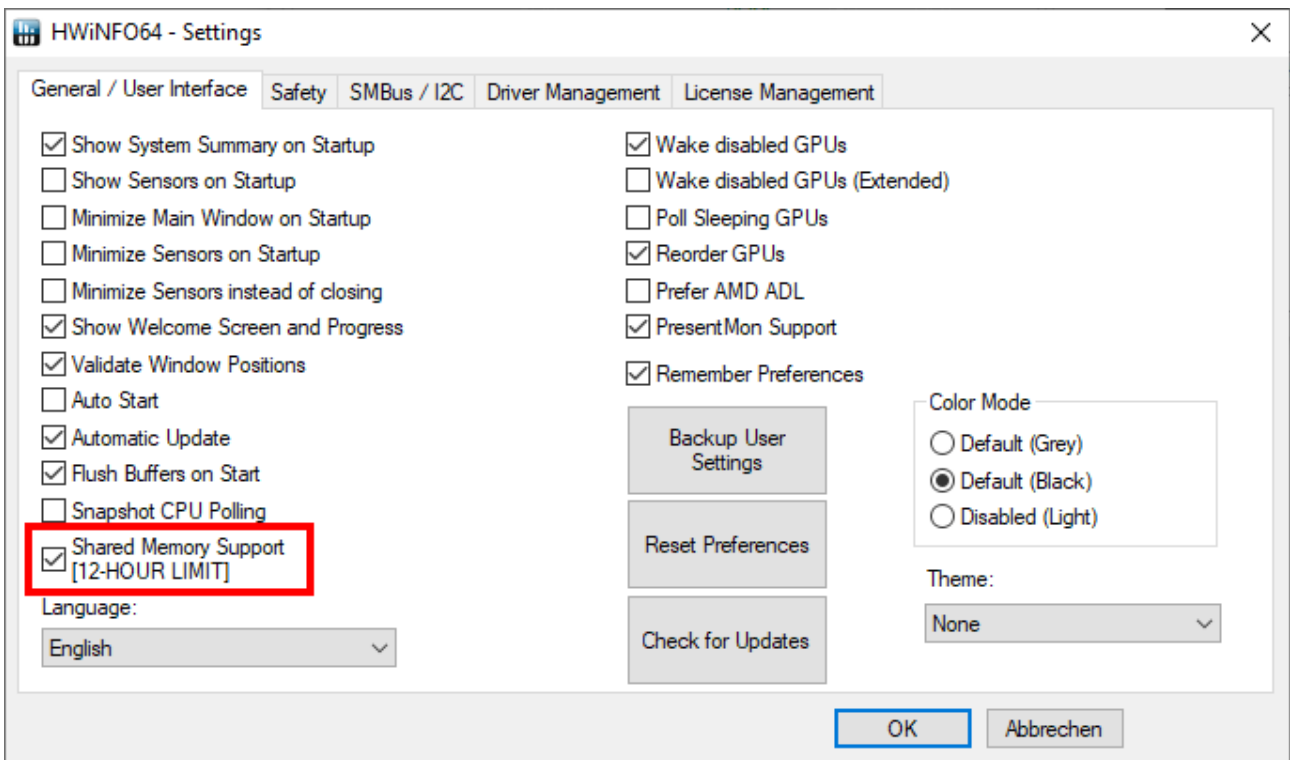

In the AIDA64 preferences menu, “Enable shared memory” must be activated in the “External Applications” sub-menu:

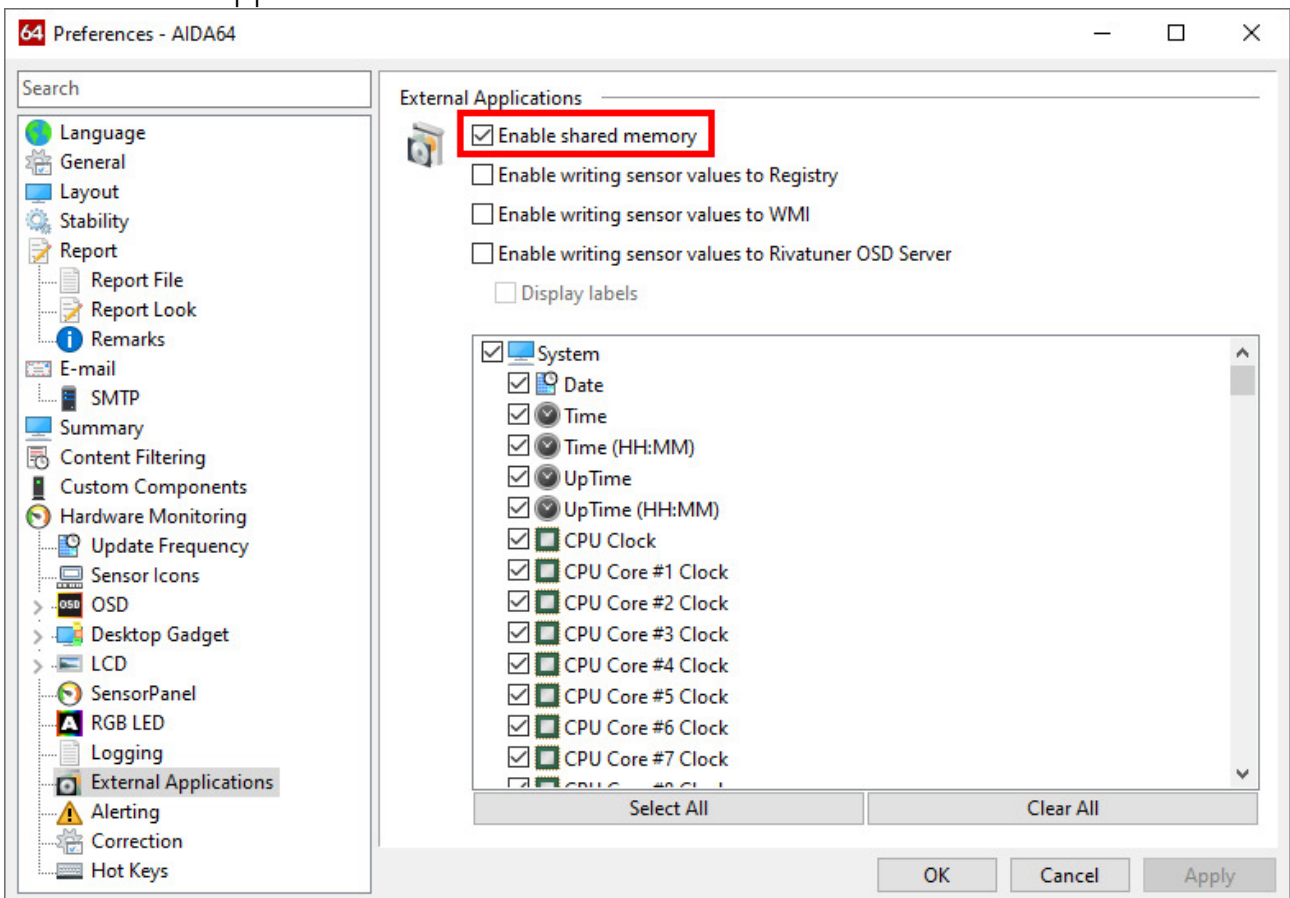

Click the “Select data source” button to assign each software sensor to a temperature sensor provided by third party software.

Transmission of sensor data via aquabus interface

Sensor data to be transmitted via aquabus is determined solely by the connected aquaero 5/6 controller. For configuration, the aquaero has to be connected to the PC (at least temporarily) via USB.

Select "aquabus" from the device list below the "aquaero" entry. From the "Currently connected aquabus devices" section, select the appropriate aquastream ULTIMATE to receive sensor data.

14.5. Water temperature sensor selection

Select one of the available temperature sensors to be displayed as "Water temperature" in the information pages on the pump display. This sensor is also available as a data source for all temperature controllers. If the currently selected sensor does not read valid data, the pump will automatically default to the internal water temperature sensor instead.

15. Display configuration and information pages



aquasuite: Select "Display" from the device list below the "aquastream ULTIMATE" entry.

Device menu: Select "Display" from the menu list and confirm by pressing the middle key.

15.1. Display settings

Units for temperature and flow measurement can be selected, display brightness and page interval can be adjusted.

As with all OLED displays, the brightness of active pixels will reduce over time. For a homogeneous wear of all pixels, the display can automatically be inverted half of the time. In order to counteract existing wear, the inverted mode can be permanently activated.

15.2. Charts

Four configurable chart pages are available to be displayed in the pump display. Data source and refresh rate can be selected for each chart.

15.3. Display pages

During normal operation, a variety of predefined display pages are available. Each of these pages can be activated or deactivated individually.

16. Profiles

aquasuite: Select "Profiles" from the device list below the "aquastream ULTIMATE" entry.



The profile management can be used to save four configurations as profiles and activate them manually or automatically. Profile management is a software feature of the aquasuite and requires a USB connection to the aquastream ULTIMATE.

16.1. Manual profile selection

Select the profile to be activated by clicking the corresponding button.

16.2. Automatic profile selection

Profiles can be activated automatically using the global profiles feature of the aquasuite, see chapter 18.4. for details.

16.3. Profile configuration

All configuration changes are automatically stored in the currently active profile. The current configuration can also be stored in any other profile by clicking the corresponding button.

17. System settings aquastream ULTIMATE

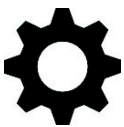

aquasuite: Select "System" from the device list below the "aquastream ULTIMATE" entry.

Device menu: Select "System" from the menu list and confirm by pressing the middle key.

17.1. Device information

The details displayed here might be required when you contact our service for support. You may enter a "Device description" for easier identification, this text will be displayed in the device list and in the data quick view.

17.2. Factory defaults

Click the button "Reset device to factory defaults" in the aquasuite or select the "Factory defaults" entry from the menu for a complete reset of all settings. You will have to completely reconfigure the device after resetting it to factory defaults!

17.3. aquabus configuration

Before connecting two aquastream pumps simultaneously to an aquaero 5/6 via aquabus, each pump has to be configured to a unique aquabus address. If only one device is connected via aquabus, this step may be skipped. Address 17 and 18 are available. Please note that aquastream ULTIMATE and aquastream XT as well as D5 NEXT share resource assignments in the aquabus device handling of

the aquaero. A combined maximum of two pumps of these types can be managed by the aquaero.

Changes to the bus address or aquabus sensor configuration are effective within a few seconds. However, it may take up to five minutes for a connected aquaero to update its configuration.

17.4. Additional features (aquasuite only)

Two additional features are available for the aquastream ULTIMATE, the advanced controller package and the virtual flow sensor extension. After initial operation, both features are activated for a trial period of 48 hours of operation. The features are deactivated after expiration of this trial period, but can be permanently enabled at any time by purchasing a software key. To buy a key, please click one of the buttons in the aquasuite software, you will be redirected to a corresponding web portal on our website (internet connection required).

After having received a key file, you can simply drag&drop this file from your email program or file system to the “activate function” button, or click the button and select the file manually. The new features are immediately activated.

17.5. Firmware update and language selection (aquasuite only)

The most up to date firmware for all supported devices is always included in the current version of the aquasuite software. The button “Update firmware now” will start the update process for the device firmware.

During the firmware update process, the language of the pump menu will automatically be set to the currently selected language in the aquasuite software. To change the language of the pump menu, first select the desired language in the basic aquasuite settings and restart the aquasuite software. Afterwards, perform a firmware update of the aquastream ULTIMATE to change the language of the pump.

During the firmware update process, do not disconnect the device from the PC and do not power down the PC! After the firmware is successfully updated, the aquasuite software will be automatically closed.

18. Playground (aquasuite)

Click the entry “Playground” to configure Virtual Software Sensors, global profile management and hotkeys.

18.1. Input values



Input values defined in this section can be manipulated by individually configured control elements, for example sliders or buttons.

Create a new input value by clicking the plus symbol in the upper right corner of the “Input values” window and configure the properties as desired. A name, an

icon, a unit, a range of values as well as a initial value can be assigned to each input value. This new input value will then be available to be displayed on overview pages and in the quick view section and can be used as a data source for software sensors and virtual software sensors.

In the lower area of the window, control elements can be created and configured to manipulate the input value. These preconfigured control elements can then be used for overview pages or in the system tray.

18.2. Virtual Software Sensors



Virtual Software Sensors can be used for extensive yet easy to use adaptation and calculation of sensor values using mathematical and logical functions as well as filters.

Create a new Virtual Software Sensor by clicking the plus symbol in the upper right corner of the “Virtual Software Sensors” window. Each Virtual Software Sensor always has an “Out” element which will provide the resulting sensor value. In the settings dialog of this element, the name and unit of the sensor can be configured. You can now add data sources and function blocks to the lower area of the sensor window and connect inputs and outputs of the blocks with lines. Connect the output of the last function block with the “Out” element.

The resulting virtual sensor can be used within the aquasuite software, for example for overview pages, additionally it may be transmitted via USB connection to connected devices that feature software sensors.

The following (very simple) example calculates the average out of two temperatures:

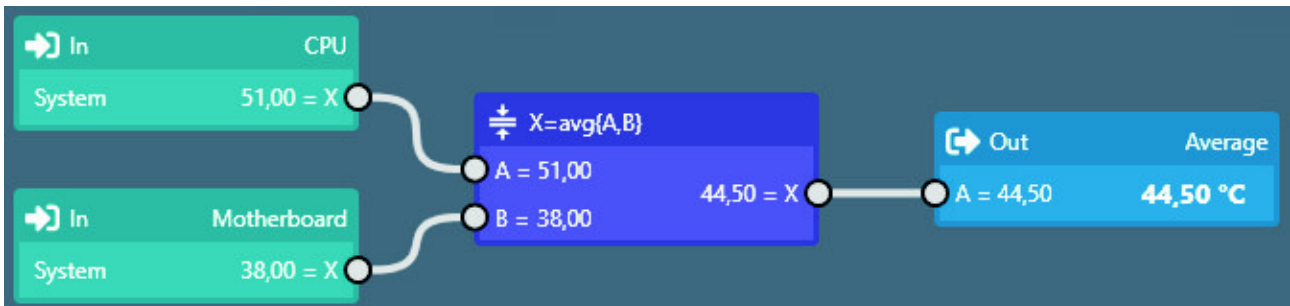

Virtual software sensors are updated once per second and re-calculated with the numbers valid in that particular moment. When using fast changing input values, extreme values can therefore either be used or ignored for the calculation. No smoothing or averaging is taking place.

18.3. Output actions



While the virtual software sensors are used as a value within the aquasuite, output actions configured in this section are used to trigger events.

Various notification events including emails and MQTT messages are available. Additionally, external programs can be started.

Create a new output action by clicking the plus symbol in the upper right corner of the “Output actions” window and configure the properties as desired. Each output

action always has an “Output” element which represents the event itself. In the settings dialog of this element, the event to be executed can be selected and configured.

You can now add data sources and function blocks to the lower area of the window and connect inputs and outputs of the blocks with lines. Connect the output of the last function block with the “Output” element. The event will be executed when the input of the “Output” element reaches a value greater than zero.

Output actions are updated once per second and re-calculated with the numbers valid in that particular moment. When using fast changing input values, extreme values can therefore either be used or ignored for the calculation. No smoothing or averaging is taking place. Example: If thresholds are exceeded for very short periods of time lasting less than one second, the action can be executed or not be executed seemingly at random, depending on whether the thresholds is exceeded in the exact moment the calculation is performed.

18.4. Global profiles



The global profile management can be used to conveniently change settings in multiple devices simultaneously and activate desktop pages. Individual actions can be defined for each of the four profiles, switching between profiles can either be done manually or automatically depending on configurable rules.

In order to use this feature, set up profiles within the individual device configurations first. These profiles can then be activated using the global profile management. Not every type of device supports profiles.

Buttons in the upper window area can be used to switch between global profiles. Alternatively, the profile icon in the title bar of the aquasuite window or a profile icon in the system tray may be used.

Example use cases: Switching of LED illumination settings depending on current time of day or modification of fan settings when a graphics application is launched.

Notice for profile activation depending on running applications: During configuration of the respective rule in the aquasuite, the application to be configured must already be running. The application selection within the aquasuite will always show currently running applications and processes only.

18.5. Hotkeys



Hotkeys are key combinations that will be processed system-wide and can activate global profiles or desktop pages. The configured key combinations will be registered in the operating system and be processed by the background service. If the configured actions only use the profile management, the aquasuite does not have to be running for hotkeys to be operational; if desktop pages are used, the aquasuite must be running.

Do not use key combinations for this function that are required by other applications.

19. aquasuite web

Click the entry “aquasuite web” to publish data on the internet or import data from the internet. The server for this service is operated by Aqua Computer and provided for use with the aquasuite, without warranty for error free operation or permanent availability. Aqua Computer reserves the right to limit or cancel this service at any time.

19.1. Data export



To publish data, create a new export data set by clicking the plus symbol in the upper right corner of the “Data export” window. The name of the data set may be modified to meet your requirements. You may then add the data sources to export by clicking the plus symbol in the “Data sources” window section. By clicking the gear symbol, the name of the corresponding value can be changed. Up to 30 data sources can be added to each export data set, the total number of export data sets is limited to 10. All selected values will be transmitted to the Aqua Computer server by the Aqua Computer background service approximately every 15 seconds, even after closing the aquasuite.

Notice regarding data security: All data contained in the configured export data sets is transmitted to the Aqua Computer server with transport security. The server stores the data set in volatile memory until a new data set is received or until 10 minutes have passed. Data received is not permanently stored, data is also not correlated to IP addresses or other personal data. Data on the server may be accessed by anyone without restrictions, furthermore automatic data collection and recording through third parties is possible. Use the data export feature for data that you want to publish publicly and are allowed to do so only.

19.2. Data access



Published data can be obtained from the Aqua Computer server in various formats. Generally, the “access key” is required to access data.

In addition to access through any internet browser and importing data into the aquasuite, data is also available in JSON format and compatible to Circonus. Furthermore, the server generates banner images in two different sizes from the transmitted data, suitable to be included in forums signatures. The code required for the Aqua Computer forums is provided for your convenience.

19.3. Data import



To import a data set from the Aqua Computer server, the “access key” of the data set is required. The access key can be found in the aquasuite on the computer providing the data in the “Data access” section.

Create a new import entry by clicking the plus symbol in the upper right corner of the “Data import” window. Enter the access key of the data set to be imported. Up to 10 data sets (each containing up to 30 values) can be configured.

In order to verify that data is being imported, use the “Data quick view” feature in the aquasuite. Navigate to “Data from Aqua Computer service”, then “aquasuite web”. For each imported data set, you should find an entry with the name of the data set containing the individual values. It may take a few seconds before imported data is displayed.

20. Basic settings (aquasuite)

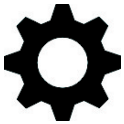

Click the entry “Settings” below the headline “aquasuite” to access basic settings for language, units and start-up of the software.

20.1. Language

Select a language from the drop down menu. After changing the language setting, the software will have to be restarted.

20.2. Create overview pages

After activating the “Generate device overview pages”, new overview pages with default settings will be created for all devices.

20.3. Reorder menu items

The order in which overview pages and devices are displayed in the list can be adjusted to your preference. Activate the reorder mode by clicking the “Edit menu order” button or by clicking and holding one of the elements for a few seconds. Sort the list items by clicking the arrow symbols and exit the reorder mode by clicking the check symbol on the right side of the window when done.

20.4. Units

Select the units to be used for temperature and flow values from the drop down menus. After changing these settings, the software will have to be restarted.

20.5. Event log

Events from various parts of the aquasuite can be saved to text files. Use the buttons to view the files either internally in the aquasuite or with an external program.

20.6. Application start-up

You may customize start-up behavior to suit your preferences. You may also select to hide the task bar symbol of the software when minimized.

20.7. Service administration

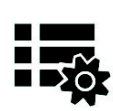

The background service configures special USB settings for all connected Aqua Computer devices, provides hardware data, software sensors, profile management, aquasuite web and Playground and should therefore always be active.

The hardware monitoring features of the background service can be disabled for specific categories if errors occur. Especially when using hardware monitoring software of different manufacturers at the same time, conflicts can occur when accessing data. Deactivate the hardware monitoring feature of the aquasuite or parts of it in this case.

When maintenance mode is activated, all optional modules of the background service are deactivated. This is useful in case of erroneous settings in the Playground, in particular if a system shutdown is configured and triggers too often. Therefore, in default configuration maintenance mode is automatically enabled if the computer is shut down three times by this feature (recommended setting).

20.8. Audio and video



The background service can analyze audio and video data and provide it to connected devices. Both functions can be enabled and disabled separately.

Notices for video analysis: Screen content preventing analysis by DRM or similar methods cannot be analyzed. If a graphics card is configured for variable refresh rate or a modified refresh rate, video analysis may fail; please deactivate this function in the graphics settings of the operating system if necessary.

20.9. Updates and update service



For software activation, all aquasuite versions starting with version 2017 require an active update service for the initial release date of the respective version. Update service periods are generally assigned to individual devices, brand-new devices automatically contain update service for a specific period depending on the type of the device. For software activation, at least one device in the computer must contain a corresponding update service period that includes the release date of this software version. If a valid update service period is detected for at least one device, all devices connected to the computer can be used with this version. It is not mandatory that each device has a corresponding update service period. For update service validation, the aquasuite requires an internet connection.

After successful validation, a file containing current data is stored on the computer. A re-validation is performed only if a new software version (update) is installed or upon connection of new devices. New devices can not be used prior to re-validation, even if other devices with corresponding update service periods are connected at the same time.

To purchase update service, please use the “Buy” button, which will open a website with current prices and payment options.

If you have received a key for update service with a device or bought one separately, you may enter the key after clicking the “Register” button. Select a currently connected USB device from the list for update service assignment. After clicking

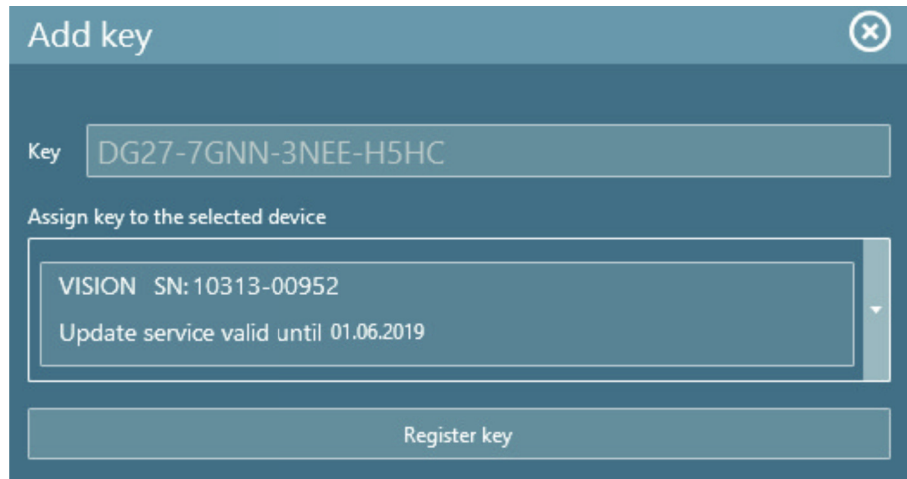

the “Register key” button, the update service period is permanently assigned to the selected device and stored on the Aqua Computer update server. The key will not have to be re-entered after re-installation of the software or transfer of the device to another computer, but transferring the update service period to another device is not possible.

During update service validation and software activation, device serial numbers and a calculated computer ID are transmitted to and stored on the update server. No further personal information such as IP addresses are stored.

20.10. E-mail and MQTT accounts



Accounts for sending e-mail or MQTT messages can be configured. These accounts can then be used to send messages in the “Outputs” section of the Playground.

21. Troubleshooting

21.1. Restore factory defaults

There are three options to reset the pump controller to factory defaults. Restoring factory defaults may be useful if the pump is not properly operating or if erroneous settings have been saved into the pump.

1. aquasuite: Click the “Reset device to factory defaults” button on the “System” screen.

2. Device menu: Select "System", then "Factory defaults" and confirm by pressing the middle key.
3. Turn off the PC. Press and hold the middle key and turn on the PC. Release the key once pump data is displayed.

21.2. Replacement parts

The following genuine parts can be used with the aquastream ULTIMATE pump:

Description	Aqua Computer part number	Eheim part number
Pump cover	41032	7439909
Gasket for pump cover	92014	7263550
Ceramic axis	41031	7433720
Impeller incl. ceramic axis	41065	Not compatible!
Mounting plate	41036	7264509
Suction grille	41086	7263609

All spare parts can be obtained from Aqua Computer. Eheim spare parts may also be available from local aquarium supply stores.

22. Technical details and care instructions

22.1. Technical details

Power supply voltage (V _{in}):	12 V DC ±5 %
Power consumption:	ca. 3 to 25 Watts
Maximum pump pressure:	445 mbar (approx. 4.45 m water head)
Fan output voltage:	0-11.5 V DC (max. V _{in} – 0.5 V if current > 40 mA, max V _{in} – 1 V if current < 40 mA)
Fan output current:	max. 1.0 A
Speed signal connector:	open collector max. 30 V / 50 mA
Ambient temperature range:	10 to 40 °C (noncondensing)
Coolant temperature:	0-50 °C
Dimensions (L x W x H)	118 x 75 x 72 mm (without fittings)

22.2. Care instructions

Use a dry and soft cloth for cleaning. All electronic components and headers must not get in contact with coolant or water!

22.3. Waste disposal

This device has to be disposed of as electronic waste. Please check your local regulations for disposal of electronic waste.



22.4. Contact Aqua Computer

We are always happy to answer questions regarding our products and to receive feedback. For answers on frequently asked questions, please also check our website www.aqua-computer.de. You might also want to visit our forums and discuss our products with experienced moderators and thousands of members – available 24/7. To get in direct contact with our customer support team, we offer several options:

Email: support@aqua-computer.de

Postal address: Aqua Computer GmbH & Co. KG
Gelliehäuser Str. 1
37130 Gleichen
Germany

Tel: +49 (0) 5508 9749290 (9-16 h CET, German and English language)